

4411 Model

Masoneilan* Electropneumatic Transducer

Instruction Manual



THESE INSTRUCTIONS PROVIDE THE CUSTOMER/OPERATOR WITH IMPORTANT PROJECT-SPECIFIC REFERENCE INFORMATION IN ADDITION TO THE CUSTOMER/OPERATOR'S NORMAL OPERATION AND MAINTENANCE PROCEDURES. SINCE OPERATION AND MAINTENANCE PHILOSOPHIES VARY, GE (GENERAL ELECTRIC COMPANY AND ITS SUBSIDIARIES AND AFFILIATES) DOES NOT ATTEMPT TO DICTATE SPECIFIC PROCEDURES, BUT TO PROVIDE BASIC LIMITATIONS AND REQUIREMENTS CREATED BY THE TYPE OF EQUIPMENT PROVIDED.

THESE INSTRUCTIONS ASSUME THAT OPERATORS ALREADY HAVE A GENERAL UNDERSTANDING OF THE REQUIREMENTS FOR SAFE OPERATION OF MECHANICAL AND ELECTRICAL EQUIPMENT IN POTENTIALLY HAZARDOUS ENVIRONMENTS. THEREFORE, THESE INSTRUCTIONS SHOULD BE INTERPRETED AND APPLIED IN CONJUNCTION WITH THE SAFETY RULES AND REGULATIONS APPLICABLE AT THE SITE AND THE PARTICULAR REQUIREMENTS FOR OPERATION OF OTHER EQUIPMENT AT THE SITE.

THESE INSTRUCTIONS DO NOT PURPORT TO COVER ALL DETAILS OR VARIATIONS IN EQUIPMENT NOR TO PROVIDE FOR EVERY POSSIBLE CONTINGENCY TO BE MET IN CONNECTION WITH INSTALLATION, OPERATION OR MAINTENANCE. SHOULD FURTHER INFORMATION BE DESIRED OR SHOULD PARTICULAR PROBLEMS ARISE WHICH ARE NOT COVERED SUFFICIENTLY FOR THE CUSTOMER/OPERATOR'S PURPOSES THE MATTER SHOULD BE REFERRED TO GE.

THE RIGHTS, OBLIGATIONS AND LIABILITIES OF GE AND THE CUSTOMER/OPERATOR ARE STRICTLY LIMITED TO THOSE EXPRESSLY PROVIDED IN THE CONTRACT RELATING TO THE SUPPLY OF THE EQUIPMENT. NO ADDITIONAL REPRESENTATIONS OR WARRANTIES BY GE REGARDING THE EQUIPMENT OR ITS USE ARE GIVEN OR IMPLIED BY THE ISSUE OF THESE INSTRUCTIONS.

THESE INSTRUCTIONS ARE FURNISHED TO THE CUSTOMER/OPERATOR SOLELY TO ASSIST IN THE INSTALLATION, TESTING, OPERATION, AND/OR MAINTENANCE OF THE EQUIPMENT DESCRIBED. THIS DOCUMENT SHALL NOT BE REPRODUCED IN WHOLE OR IN PART WITHOUT THE WRITTEN APPROVAL OF GE.

Table of Contents

Safety Warning.....	1
Brief User Guide	2
General Description	2
Instrument Mounting.....	3
Captured Bleed Version	3
Pneumatic Installation.....	3
Electrical Installation.....	4
Wiring and Cable Entry	4
Conduit Entry	4
Calibration	4
Tight Shut-Off Adjustment Instructions.....	5
Simple Functional Checks	5
Technical Specifications	6
Performance.....	6
Potentially Explosive Atmospheres – Markings.....	7
Instructions Specific to Hazardous Area Installations.....	8
Instructions – Special Condition for Safe Use.....	8
FM Control Drawing.....	9
CSA Control Drawing.....	10

Safety Information

Important - Please Read Before Installation

These instructions contain **DANGER**, **WARNING**, and **CAUTION** labels, where necessary, to alert you to safety related or other important information. Read the instructions carefully **before** installing and maintaining your control valve. **DANGER** and **WARNING** hazards are related to personal injury. **CAUTION** hazards involve equipment or property damage. Operation of damaged equipment can, under certain operational conditions, result in degraded process system performance that can lead to injury or death. Total compliance with all **DANGER**, **WARNING**, and **CAUTION** notices is required for safe operation.



This is the safety alert symbol. It alerts you to potential personal injury hazards. Obey all safety messages that follow this symbol to avoid possible injury or death.



Indicates a potentially hazardous situation which, if not avoided, could result in death or serious injury.



Indicates a potentially hazardous situation which, if not avoided, could result in serious injury.



Indicates a potentially hazardous situation which, if not avoided, could result in minor or moderate injury.



When used without the safety alert symbol indicates a potentially hazardous situation which, if not avoided, could result in property damage.

Note: Indicates important facts and conditions.

About this Manual

- The information in this manual is subject to change without prior notice.
- The information contained in this manual, in whole or part, shall not be transcribed or copied without Masoneilan's written permission.
- Please report any errors or questions about the information in this manual to your local supplier.
- These instructions are written specifically for the 4411 IP Transducer, and do not apply for other instruments or IP transducers outside of this product line.

Warranty

Items sold by General Electric are warranted to be free from defects in materials and workmanship for a period of one year from the date of shipment provided said items are used according to GE recommended usages. GE reserves the right to discontinue manufacture of any product or change product materials, design or specifications without notice.

This instruction manual applies to the Masoneilan 4411 IP Transducer.

Note:

- The 4411 IP Transducer **MUST BE** installed, put into service and maintained by qualified and competent professionals who have undergone suitable training.
- Under certain operating conditions, the use of damaged equipment could cause a degradation of the performance of the system which may lead to personal injury or death.
- Changes to specifications, structure, and components used may not lead to the revision of this manual unless such changes affect the function and performance of the product.
- All surrounding pipe lines must be thoroughly flushed to ensure all entrained debris has been removed from the system.

IMPORTANT: SAFETY WARNING

Please read these instructions carefully **BEFORE** this instrument is installed or maintained.

These converters are intended for use in industrial compressed air systems only. Ensure that adequate pressure relief provision is installed if application of system supply pressure could cause downstream equipment to malfunction. Installation should be in accordance with local and national compressed air and instrumentation codes.

Products certified for use in explosion-proof or intrinsically safe installations **MUST:**

- a) Be installed in accordance with local and national codes for hazardous area installations, and in accordance with this manual.
- b) Only be used in situations which comply with the certification conditions stated in this handbook.
- c) Only be maintained by qualified personnel with adequate training on hazardous area implementation.

Before using these products with fluids other than air or for non-industrial applications consult GE.

Brief User Guide

This is a quick guide to connecting the instrument for the convenience of personnel who are familiar with this type of product.

More comprehensive instructions are contained later in this manual:

1. Connect a clean air supply of about 2.0 bar (30 psig for the 3-15 psig output model, or 2.4 bar (35 psig) for the 6-30 psig output model) to the IN port (1/4" NPT).
2. Connect a pressure gauge or actuator to the OUT port.

CAUTION

DO NOT use PTFE tape or similar to seal the ports. Use a minimum of soft setting anaerobic compound, e.g. Loctite Hydraulic Seal 542.

3. Unscrew the lid to obtain access to the terminals.

! DANGER

The cable will need to be sealed by an approved gland for explosion-proof installation.

! DANGER

The second un-used conduit entry must be sealed with an explosion-proof blanking plug.

4. Connect a 4-20mA current source, either through the Jack-Plug source or Terminal connections. Ensure that it can supply at least 6.5V at 20mA. Check for correct polarity.

CAUTION

DO NOT use a voltage source; it will irreversibly damage the converter.

5. Switch on the air supply and current source and allow a few seconds stabilisation time. Adjust span and zero via the trimpots if necessary.

If the instrument fails to operate refer to the Simple Functional Checks.

General Description

These converters are precision electronic pressure controllers designed for continuous process control applications. The units operate a closed loop system incorporating a feedback sensor ensuring long-term stability and high accuracy performance, with 'fail-safe' operation, i.e. the output falls to a low pressure upon failure of the loop current.

These instruments combine substantial flow capacity, with the ability to give precise control into closed volume 'dead end' applications.

The instrument has been designed to withstand the rigours of industrial environments; such as shock, vibration and positional effects. As with any other precision instrument dropping the unit onto a hard surface may result in shifts in calibration or possibly permanent damage. The unit may be mounted directly upon a control valve. A mounting bracket is provided for surface mounting, or the instrument may be fixed directly to rigid pipework.

The electronics are enclosed within a watertight housing, which is suitable for outdoor use if a suitable cable gland is used. The lid should be firmly tightened, the use of a tool for this purpose is not recommended.

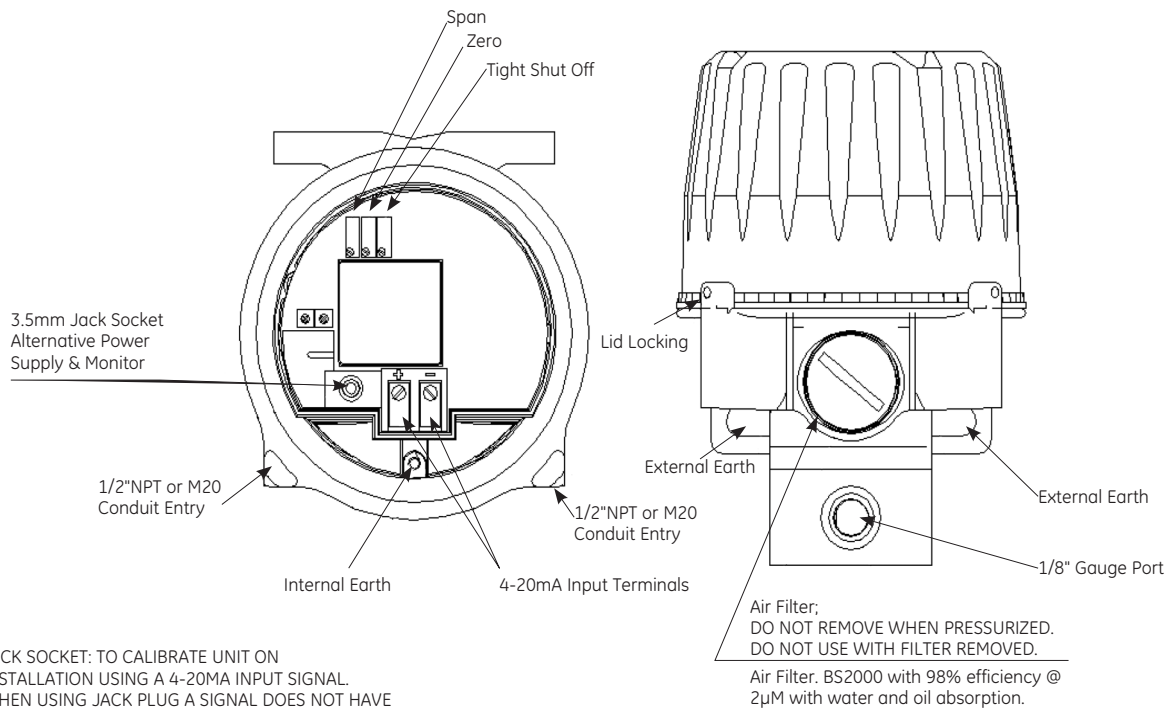

JACK SOCKET: TO CALIBRATE UNIT ON INSTALLATION USING A 4-20MA INPUT SIGNAL. WHEN USING JACK PLUG A SIGNAL DOES NOT HAVE TO BE SUPPLIED VIA THE TERMINAL BLOCK. THE INPUT SIGNAL CAN BE MONITORED THROUGH THE JACK PLUG SOCKET WHEN UNIT IS IN OPERATION.

Figure 1

To meet the EMC specifications, screened cable should be used for installation. The cable screen should be connected to the internal earth bonding point of the I/P. An earth strap should also be connected from the external earth bonding point of the I/P to a common earth point. The cable screen should **not** be connected at the signal source when used in Intrinsically Safe (IS) environments. The I/P has been thoroughly tested in accordance with:

Electromagnetic compatibility (EMC)

Generic Standards – Immunity for industrial environments

Electromagnetic compatibility (EMC)

Generic Emissions Standard – Industrial environment

Please consult wiring diagram for further information. The results obtained from these tests show that with the screen arrangement shown in the installation diagram, the typical sustained output pressure shift is $\pm 5\%$ full scale. Consult supplier for further details.

Instrument Mounting

The converter can be mounted directly onto a valve, onto any suitable flat surface, or onto 2" (50mm) pipe. Dimensional details:

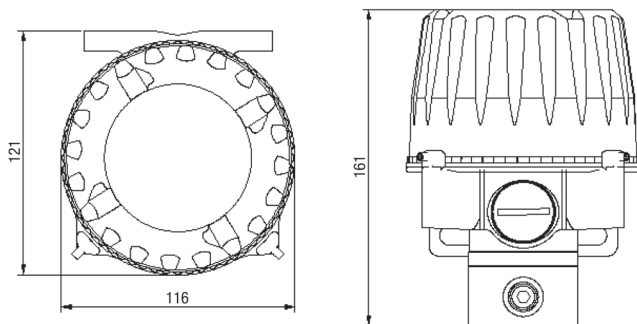

Figure 2

These converters will operate in any position, with slight re-calibration adjustments, normal operation is in the upright position, i.e. with the screwed lid horizontal. The unit is weather resistant when the lid is removed for connection or calibration, but should not be left uncovered during operation or for extended periods of time. They are unaffected by shock and vibration, but severe vibration environments are best avoided.

The instruments are protected against environmental effects, to a level of Type 4X (IP66). Sensible positioning should be used if the local environment is severe.

Temperature compensation is designed into these converters which will operate over a range from -40° to $+85^{\circ}\text{C}$ (-40° to $+185^{\circ}\text{F}$). Maximum life is obtained if extreme temperature cycling is avoided. In extreme direct sunlight, sun-shading is advised.

The pneumatic exhaust and the bleed are routed through the baffles. The baffles must not be blocked with paint and/or plastic sheeting etc.

Captured Bleed Version

The baffles and the baffle cover are fitted to maintain the adequate Ingress Protection (IP) rating of the instrument. Removal of these protective parts will invalidate the IP and the NEMA 4X rating of the instrument.

For captured bleed installation, remove the baffle cover and unscrew both the baffles, fit 1/8" NPT fittings to two separate lengths of pipes, to exhaust and bleed gas to a safe area installation.

Vented gas from the enclosure through bleed port must not be re-circulated and introduced back into the process stream. Exhaust port installation must not have any restriction to create backpressure to cause instrument to malfunction. Instrument installation for captured bleed version must be under the installer's discretion.

Note: Exhaust Port is nearer the conduit entry (LH side) Enclosure Bleed Port is on the RH side. (See Figure 3.)

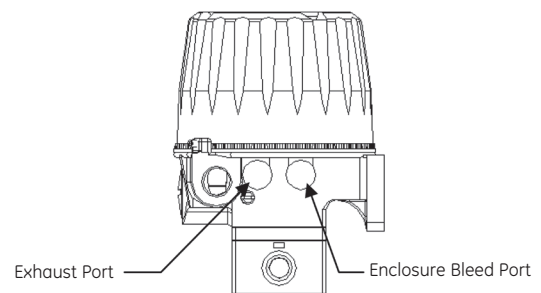

Figure 3

Pneumatic Installation

These instruments are recommended for use with clean, dry, oil free instrument grade air to BS.6739:1986 or ANSI/ASA-57.3 1975 (R1981).

Dew Point: At least 10°C (18°F) below (-40°C) minimum anticipated ambient temperature.

Dust: Filtered to below 50 microns.

Oil Content: Not to exceed 1ppm mass.

The instrument is factory calibrated with a supply pressure of 30 psig (2 bar) $\pm 10\%$. Operation is possible at any pressure between 18 and 150 psig (1.3 to 10 bar), though recalibration may be necessary towards these limits to maintain specified accuracy.

The inlet and outlet ports are threaded 1/4" NPT female and suitable fittings should be used. For most installations 1/4" (6mm) pipe will be adequate. If a large actuator, high flow rates or long pipework is necessary then a larger diameter should be used.

Plastic tubing, e.g. Nylon is preferable where circumstances permit, since it is normally very clean internally. In all cases, purge the supply pipework before connection to the converter.

Two gauge ports are provided to facilitate direct mounting of a pressure gauge. To use one of these ports remove the plug (using a 1/4" or 3/16" Hexagon Key) in a de-pressurized state, and connect the gauge. The ports are threaded 1/4" NPT at the back of the unit and 1/8" NPT at the front.

CAUTION

Under no circumstances should PTFE tape be used for sealing the fittings as this tends to shred small particles which may find their way into the instrument causing malfunctions.

The use of a soft setting anaerobic hydraulic seal is recommended, (e.g. Loctite Hydraulic Seal 542). Follow the manufacturers recommendations.

CAUTION

Do not use an excessive amount as this will not set and could find its way into the instrument.

If the air supply is not of adequate quality, the device performance can be affected. Adequate quality can normally be achieved by the use of air filter regulators.

Electrical Installation

The electrical connections should be made as shown in the dimensional drawing Figure 1. The instrument is protected against reverse polarity to -100mA, no operation is possible in this condition.

The Model 4411 approximates a constant voltage load of 6.5 volts across the loop terminals, therefore it is essential that the loop controller be capable of providing a constant current in the range 4-20mA with an output voltage of at least 6.5 volts.

CAUTION

Voltage output controllers (e.g. variable voltage power supplies) are entirely unsuitable for the Model 4411 and could severely damage the electronic circuits.

Important Note

The control electronics of the Model 4411 incorporate precision electronics. The calibration of the unit may be affected by very high voltage spikes. Consequently, in environments where static electricity may be present ESD precautions should be used.

Wiring And Cable Entry

WARNING

These instruments must be installed in accordance with local and national codes of practice, especially for hazardous area installations. The instruments are fully isolated from ground and therefore grounding is unnecessary for functional purposes. However, grounding may be necessary to conform to installation codes.

Note: It is strongly recommended that shielded cable or a grounded conduit be used to achieve maximum RFI immunity, if the installation has any risk of electromagnetic interference.

Conduit Entry

The instrument has twin conduit entry threaded 1/2" NPT. For explosion proof installation, a sealed conduit gland conforming to explosion-proof specifications must be used. A ground terminal is provided both internally and externally and should

be used if ground continuity is essential.

DANGER

The unit is supplied with plastic blanking plugs, which must be removed before operation/calibration and replaced with a blanking plug conforming to the hazardous area certification rating applicable.

Calibration

The instruments are designed for continuous operation without the necessity for routine overhaul, with continuous monitoring, adequate precautions and replacement of the filter no longer than every 5 years.

The most common source of failure for pneumatic instrumentation has been found to be inadequate air quality, allowing contaminants to block internal orifices. Air filtering is included within the instrument but cannot cope with sustained poor air quality, which may ultimately lead to failure.

The recommendations in the Pneumatic Installation section should be rigorously observed.

Note: These instruments are factory calibrated at a supply pressure of 30psig (2 bar).

The instrument cover must be unscrewed to obtain access to the trimpots.

DANGER

Do not remove the instrument cover in a potentially explosive atmosphere when the instrument is powered.

An accurate current source of 4-20mA and pressure gauge are required. These should be of good quality with an accuracy of 0.1% or better. The current source should be checked to ensure that it provides at least 6.5V at 20mA output compliance.

- Connect the instrument as described in the installation section or the test-jack section below.
- Remove the instrument cover to gain access to the trimpots and jack-socket.
- Set the current to 4.00mA – the instrument outlet should be 3.00+/-0.05psig (0.200+/-0.003 bar). Adjust the Zero trimpot if necessary.
- For 6-30 psig output, the output pressure should be set to 6.00 ±.05 psig (0.400 ± .003 bar). Adjust trimpot as necessary.
- Set the current source to 20.00mA – the instrument outlet should be 15.00 +/-0.05psig (1.00+/-0.003 bar). Adjust the Span trimpot if necessary.
- For 6-30 psig output, the output pressure should be set to 30.00 ±.05 psig (2.00 ± .003 bar). Adjust trimpot as necessary.

If either Span or Zero controls are adjusted it may be necessary to repeat the above steps until both ends are within the calibration limits.

Alternatively the Jack Plug can be connected to calibrate and test the unit. The Jack Plug can be either set-up for Monitoring or Calibration/Operation set-up.

Calibration with the Test Jack:

Connect pin 1 of the Jack Plug to the positive (+) lead of the current calibrator and pin 3 of the Jack Plug to the negative (-) lead of the current calibrator and then insert the Jack Plug into the Test Jack. The current calibrator is now the input signal source. Calibrate as stated above. Removing the Jack Plug will return operation of the unit back over to the original current source.

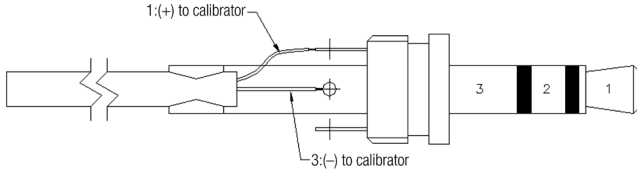

Figure 4

Monitoring with the Test Jack:

Connect pin 1 of the Jack Plug to the negative (-) lead of the ammeter and pin 2 of the Jack Plug to the positive (+) lead of the ammeter. Insert the Jack Plug into the Test Jack and use the ammeter to monitor the input current loop.

Tight Shut-Off Adjustment Instructions

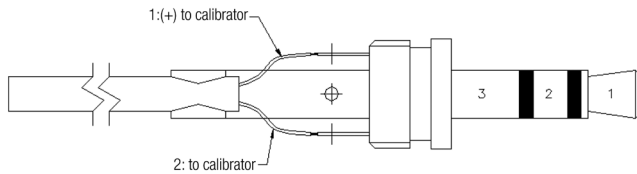

Figure 5

The Tight Shut-Off potentiometer can be adjusted to set the zero point at which the instrument 'shuts off'.

For Example:

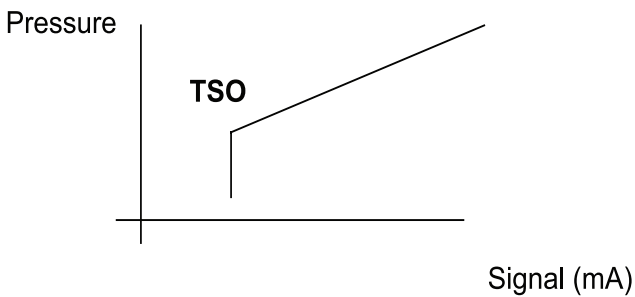

Figure 6

Setting of shut-off point:

1. With the instrument under test connected to the required supply pressure and load ports, apply a demand current signal of that value at which shut-off is required.
2. If the output pressure is >start-up pressure (~0psi), adjust potentiometer slowly clockwise until the output pressure falls to zero. Do not turn the pot beyond this point. The shut-off point is now set.

Shut-off point check:

Increase the input signal by approximately 0.5mA (e.g. to 3.8mA) the output pressure will rise above 0psi. Reset the input signal to the required shut off point (e.g. 3.3mA) and the output pressure will fall to zero.

Simple Functional Checks

Apply a 4-20mA signal and an air supply of 30psig and observe the output on a pressure gauge. It should control smoothly. The Test Jack can also be connected as a monitor measure.

Problem	Possible Causes	Suggested Action
Maximum output not available	Supply pressure too low	Check and adjust supply
	Calibration error	Recalibrate
	Air leak in instrument	Locate leak and repair
	Excess outlet flow	Check with specification
Minimum output too high	Calibration error	Replace
		Recalibrate
Delay on start up	A delay of a few seconds is normal	None
Erratic operation at low pressure	Signal currents below 3.5mA are insufficient for normal operation	Increase current
		May need recalibration
		Tight shut-off set
No output available	Tight shut off potentiometer adjusted	Turn until a pressure output is observed on gauge or pressure sensor
Erratic at all pressures	Controller cannot provide 6.5V continuously	Reduce loop resistance or change controller
	Contamination	Check I/P filter status

Technical Specifications

Functional

Input:	4-20mA (0-100%)
Output:	3-15psi and 15-3 psi or 6-30 psi and 30-6 psi Minimum output greater than 0.2psi
Supply Pressure:	150psi maximum, minimum 3psi above max required output pressure
Supply Pressure Effect:	Span over full supply pressure range <0.1%
Medium:	Standard instrument quality air to 50 micron
Air Consumption:	<2.5l/min (0.09 scfm) at 50% signal
Operating Temperature:	-40°C to 85°C (-40° F to +185° F)
Relative Humidity:	0 to 100% Relative Humidity
Output Capacity:	>300l/min (12scfm) delivery and exhaust at 100% signal
Maximum Terminal Voltage:	Maximum 6.5Volts
Minimum Operating Current:	Less than 3.5mA
Current Reversal Protection:	No effect within normal 4-20mA range protected to 100mA continuous.
Insulation:	Electrical circuits are isolated from housing. Tested to 725V DC, 100MΩ

Performance

(At 20°C (68°F), 30psi supply, 3-15psi range, for a typical instrument except otherwise stated);

Instrument Accuracy:	mean <0.1%
Independent Linearity:	mean $\leq \pm 0.05\%$ of span
Hysteresis, Resolution & Deadband:	mean $\leq 0.05\%$ of span
Accuracy Rating:	$\leq \pm 0.75\%$ span (including factory calibration error)
<i>Above figures are in accordance with ANSI/ISA 51.1:1993; N.B. Instrument accuracy excludes calibration errors</i>	
Temperature Effect:	Span and Zero Mean temperature coefficient over full operating range -40 to +85°C less than 0.035% span/degC
Vibration:	<3% of span; 4mm peak-peak 5-15Hz, 2g sine 15-150Hz
Mounting Position:	Integral bracket allows for mounting in any orientation
Long Term Stability:	Span and Zero Typically better than 0.25% span per year
Electromagnetic Compatibility:	Compliant with EC requirements: BS EN50081-2: EMC - Generic Emissions Standard – Industrial environment BS EN61000-6-2: EMC - Generic Standards – Immunity for industrial environments To meet the EMC specifications, screened cable should be used for installation. The cable screen should be connected to the internal earth bonding point of the I/P. An earth strap should also be connected from the external earth bonding point of the I/P to a common earth point. The cable screen should <u>not</u> be connected at the signal source when used in IS environments.
Controls:	Span and Zero and tight shut-off trimpots with 10% adjustment







Physical

Air Supply and Output Connections:	1/4" NPT supply and output; 1/8" NPT exhaust baffles to allow for captured bleed
Electrical:	1/2" NPT (M20 option); 2 internal screw terminals for 2.5mm ² cable
Weight:	2.07Kg

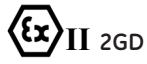
Materials

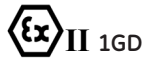
Aluminium and zinc diecasting with nitrile diaphragms, epoxy powder coat painting as standard. Weatherproof to Type 4X (IP66) [mounted upright].

Potentially Explosive Atmospheres - Markings:

Certification Agency	Flame Proof / Explosion Proof	Intrinsically Safe	Type nL, nA Non-Incendive	Others
SIRA ATEX Approved To EN60079	Sira 01ATEX1223 Ex d IIC T4 Gb (Ta = -20° to +40°C) Ex d IIB+H ₂ T5 Gb (Ta = -20° to +80°C) Ex d IIB+H ₂ T6 Gb (Ta = -20° to +65°C) Ex t IIIC T95°C Db (Ta = -20° to +85°C) Umax = 30Vdc  	Sira 01ATEX2224X Ex ia IIC T4 Ga Ex ia IIIC Da T95°C (Ta = -40° to +85°C) Ui = 30Vdc Ii = 110mA Pi = 0.84W Ci = 6nF Li = 100µH  	Sira 01ATEX4225X Ex nA nL IIC T5 Gc (Ta = -40° to +85°C) Umax = 30Vdc Ii = 24mA Ci = 6nF Li = 100µH 	
Factory Mutual Approved 	Class I, Division 1, Group BCD. T6 Ta = 75°C, T5 Ta = 85°C.	Class I, II & III, Division 1, Group ABCDEFG. T4 Ta = 85°C. Vmax = 30Vdc Imax = 110mA Ci = 0.006µF Li = 100µH Install as per Control drawing 2001-082.	Class I, Division 2, Group ABCD. T6 Ta = 75°C, T5 Ta = 85°C.	Dust Ingress Protection: Class II & III, Division 1, Group EFG. T6 Ta = 75°C, T5 Ta = 85°C. Suitable for: Class II, Division 2, Group FG, T6 Ta = 75°C, T5 Ta = 85°C; and Class III, Division 1 & 2.
CSA 	Class I, Division 1, Group BCD. Ta = -40°C to +85°C; T5 Ta = -40°C to +65°C; T6	Ex ia, Class I, Division 1, Group ABCD. Ta = -40°C to +85°C; T4 Vmax = 30Vdc Imax = 100mA Pmax = 0.75W Ci = 10.5nF Li = 100µH (30Vdc max, 300 Ohms). Install as per Control drawing 2001-083.	Class I, Division 2, Group ABCD. Ta = -40°C to +85°C; T5 Ii = 24mA Ci = 6nF Li = 100µH	

NOTE: Because of standard updates, product changes or improvements, certification level may have changed and the manual may have not been updated yet.

Please refer to device label to check updated certification level.

Instructions Specific to Hazardous Area Installations

(Reference European ATEX Directive 94/9/EC, Annex II, 1.0.6)

The following instructions apply to equipment covered by certificate numbers SIRA 01ATEX2224X, SIRA 01ATEX4225X & SIRA 01ATEX1223

1. The Model 4411 is Triple Certified, and may be installed as intrinsically safe, flameproof or Type n:
 - Zone 0 or 20 installations require the equipment to be installed as intrinsically safe via suitable associated apparatus.
 - Zone 1 or 21 installations require the equipment to be installed as intrinsically safe or flameproof; if installed as flameproof, associated apparatus is not required, but there are more onerous requirements for cable entry – refer to EN60079-0.
 - Zone 2 or 22 installations may be intrinsically safe, flameproof or Type n.
 - It is recommended that the installer indicates on the equipment which certification code applies.
2. The equipment should not be used outside the stated ambient temperature range.
3. The equipment has not been assessed as a safety-related device (as referred to by Directive 94/9/EC Annex II, clause 1.5).
4. Installation and maintenance of this equipment shall be carried out by suitably-trained personnel in accordance with the applicable codes of practice (EN 60079-14 and EN 60079-17 within Europe).
5. Repair of this equipment shall be carried out by the manufacturer or in accordance with the applicable code of practice (IEC 60079-19).
6. When installing the equipment as flameproof cable gland (M20 parallel thread) or a conduit (1/2" NPT tapered thread), the installer should verify the thread form and ensure that the appropriate matching thread is used. The pneumatic connections are not flameproof entries.
7. The certification of this equipment relies on the following materials used in its construction:
 - Enclosure: aluminium alloy and zinc alloy
 - O-ring: nitrile rubber
 - Encapsulant: polyurethane

If the equipment is likely to come into contact with aggressive substances, then it is the responsibility of the user to take suitable precautions that prevent it from being adversely affected, thus ensuring that the type of protection is not compromised.

- Aggressive substances: e.g. acidic liquids or gases that may attack metals, or solvents that may affect polymeric materials.

- Suitable precautions: e.g. regular checks as part of routine inspections or establishing from the material's data sheet that it is resistant to specific chemicals.
- Not to be used with pure oxygen or oxygen enriched media as the process fluid.

Consult the supplier for approval certificates.

8. Only approved cable glands are to be used which must maintain an Ingress Protection of IP66.
9. Unused entry port hole must be blanked off using suitably approved blanking plug.

Instructions – Special Condition for Safe Use

For Certificate Number Sira 01ATEX1223 – (Ex d) None.

For Certificate Number Sira 01ATEX2224X – (Ex ia)

1. For operation reasons, it may be necessary to connect the screen of the cable to the enclosure of the equipment in the hazardous area. If this is the case, then the equipment shall be installed in accordance with EN 60079-14:2008 (specifically clause 12.2.2.3 and 12.2.4), typically using a galvanically-isolated interface with no other connection to Earth apart from via the enclosure of the equipment.
2. The enclosure is made from light metal which could cause ignition due to impact and friction. This shall be taken into consideration when the apparatus is installed in location that specifically requires equipment protection level Ga.
3. Under certain extreme circumstances, the non-metallic parts incorporated in the enclosure of this equipment may generate an ignition-capable level of electrostatic charge. Therefore, when it is used for applications that specially require equipment protection level Ga, the equipment shall not be installed in a location where the external conditions are conducive to the build-up of electrostatic charge on such surfaces. Additionally, the equipment shall only be cleaned with a damp cloth.
4. The option for the air vented from the enclosure to be re-circulated and introduced back into the process stream shall not be used when the equipment is installed in locations that specifically require equipment protection level Ga for group II category 1G or 1D for group III category 1D equipment.

For Certificate Number Sira 01ATEX4225X – (Ex nL, nA)

1. When the equipment is energised, it shall only be opened to connect the jack socket if flammable gases or vapours are not present.
2. Provisions must be made externally to limit the supply transient from exceeding 40% of the rated input voltage (30V).
3. The apparatus enclosure has a plastic part which may present a risk of ignition due to a build up of electrostatic charge. The plastic part must not be rubbed and only cleaned by using a damp cloth.

Model 4411 I.S. CONTROL DRAWING (FM related Drg 2001-082)

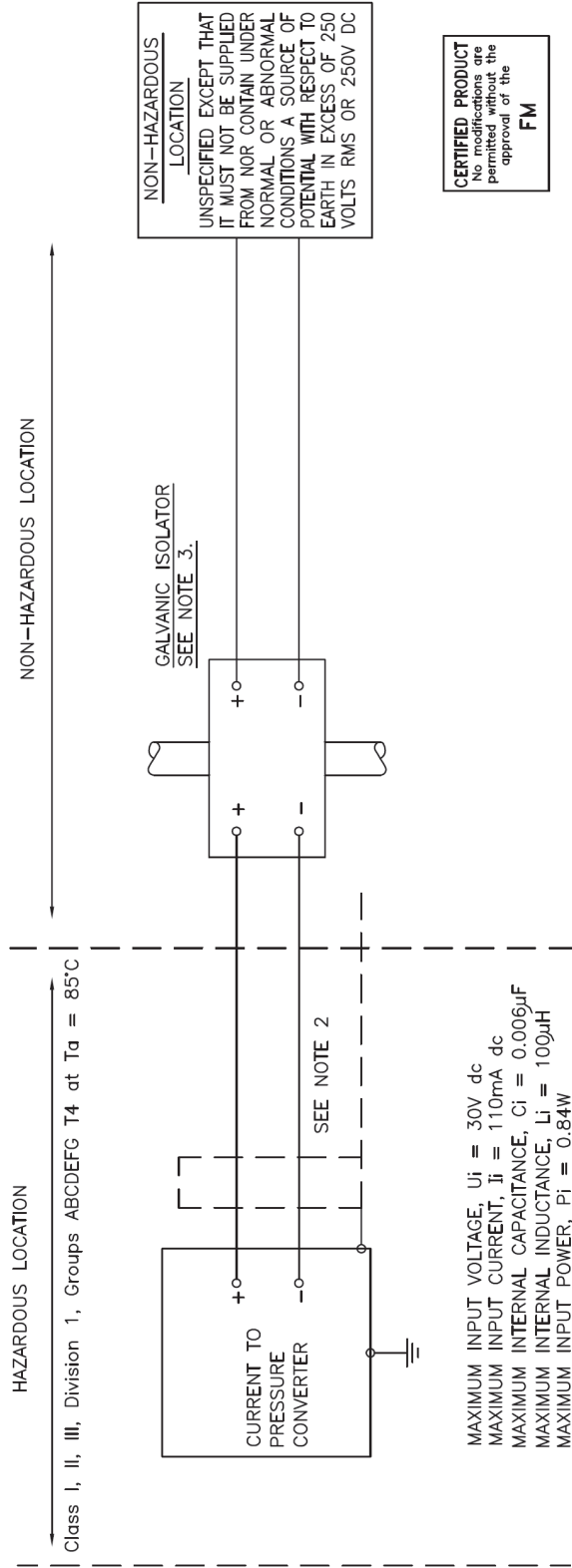

CERTIFIED PRODUCT
 No modifications are permitted without the approval of the
FM

NOTES

1. THE ELECTRICAL CIRCUIT IN THE HAZARDOUS AREA MUST BE CAPABLE OF WITHSTANDING AN A.C. TEST VOLTAGE OF 500 VOLTS R.M.S. TO EARTH OR FRAME OF THE APPARATUS FOR 1 MINUTE.
2. CABLE CAPACITANCE AND INDUCTANCE PLUS THE I.S. APPARATUS UNPROTECTED CAPACITANCE (C_i) AND INDUCTANCE (L_i) MUST NOT EXCEED THE ALLOWED CAPACITANCE (C_a) AND INDUCTANCE (L_a) INDICATED ON THE ASSOCIATED APPARATUS.
3. ANY SAFETY GALVANIC ISOLATOR WHOSE OUTPUT PARAMETERS ARE :-
 MAXIMUM OPEN CIRCUIT VOLTAGE, $U_o \leq 30\text{V}$
 MAXIMUM OUTPUT CURRENT, $I_o \leq 110\text{mA}$
 MAXIMUM OUTPUT POWER, $P_o \leq 0.84\text{W}$
4. THE INSTALLATION INCLUDING THE BARRIER EARTHING ARRANGEMENTS MUST COMPLY WITH THE INSTALLATION REQUIREMENTS OF THE COUNTRY OF USE.
 IN THE USA, INSTALLATION OF THE EQUIPMENT SHALL BE IN ACCORDANCE WITH THE NEC® AND ISA RP12.6
 RECOMMENDED PRACTICE FOR THE INSTALLATION OF INTRINSICALLY SAFE CIRCUITS.
 IN EUROPE, AS SPECIFIED IN IEC 60079-14:1996

Model 4411 I.S. CONTROL DRAWING (CSA related Drg 2001-083)

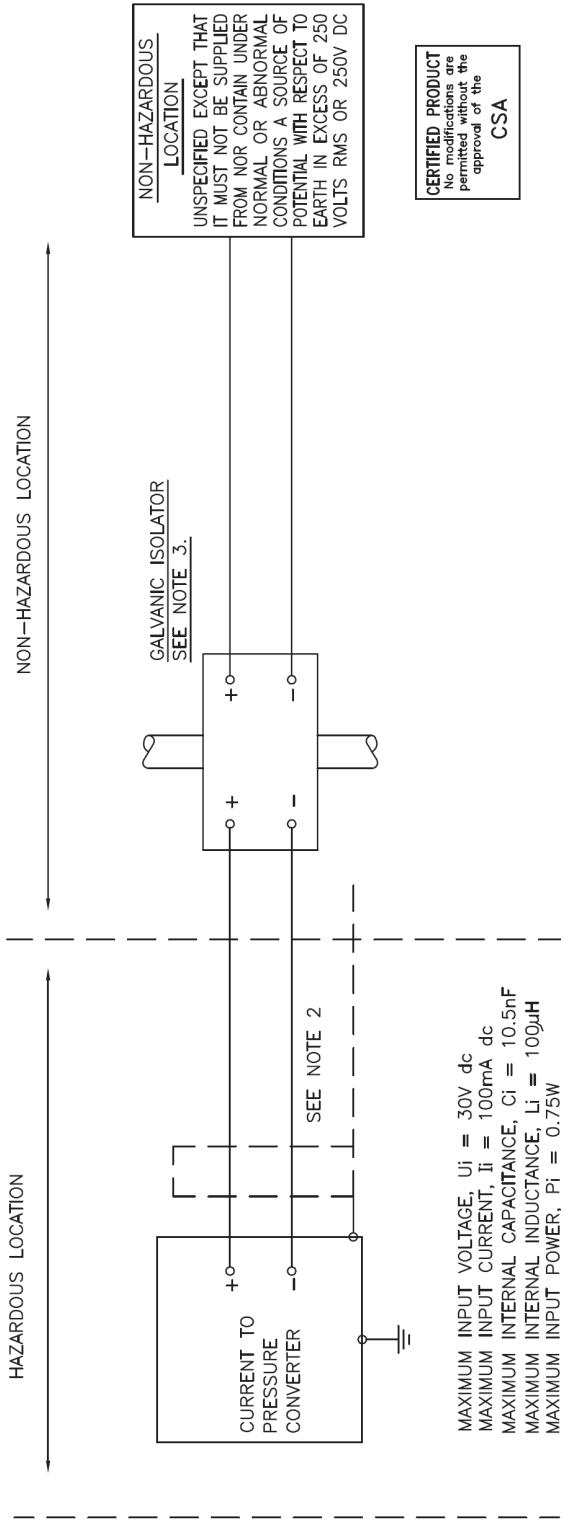

NOTES

1. THE ELECTRICAL CIRCUIT IN THE HAZARDOUS AREA MUST BE CAPABLE OF WITHSTANDING AN A.C. TEST VOLTAGE OF 500 VOLTS R.M.S. TO EARTH OR FRAME OF THE APPARATUS FOR 1 MINUTE.
2. CABLE CAPACITANCE AND INDUCTANCE PLUS THE I.S. APPARATUS UNPROTECTED CAPACITANCE (C) AND INDUCTANCE (L) MUST NOT EXCEED THE ALLOWED CAPACITANCE (Ca) AND INDUCTANCE (La) INDICATED ON THE ASSOCIATED APPARATUS.
3. ANY SAFETY GALVANIC ISOLATOR WHOSE OUTPUT PARAMETERS ARE :--
 MAXIMUM OPEN CIRCUIT VOLTAGE, $U_o \leq 30V$
 MAXIMUM OUTPUT CURRENT, $I_o \leq 100mA$
 MAXIMUM OUTPUT POWER, $P_o \leq 0.75W$
4. THE INSTALLATION INCLUDING THE BARRIER EARTHING ARRANGEMENTS MUST COMPLY WITH THE INSTALLATION REQUIREMENTS OF THE COUNTRY OF USE.
 IN THE USA, INSTALLATION OF THE EQUIPMENT SHALL BE IN ACCORDANCE WITH THE NEC® AND ISA RP-12.6
 RECOMMENDED PRACTICE FOR THE INSTALLATION OF INTRINSICALLY SAFE CIRCUITS.
 IN EUROPE, AS SPECIFIED IN IEC 60079-14:1996

Notes:

DIRECT SALES OFFICE LOCATIONS

AUSTRALIA

Brisbane:
Phone: +61-7-3001-4319
Fax: +61-7-3001-4399

Perth:
Phone: +61-8-6595-7018
Fax: +61 8 6595-7299

Melbourne:
Phone: +61-3-8807-6002
Fax: +61-3-8807-6577

BELGIUM

Phone: +32-2-344-0970
Fax: +32-2-344-1123

BRAZIL

Phone: +55-11-2146-3600
Fax: +55-11-2146-3610

CHINA

Phone: +86-10-5689-3600
Fax: +86-10-5689-3800

FRANCE

Courbevoie
Phone: +33-1-4904-9000
Fax: +33-1-4904-9010

GERMANY

Ratingen
Phone: +49-2102-108-0
Fax: +49-2102-108-111

INDIA

Mumbai
Phone: +91-22-8354790
Fax: +91-22-8354791

New Delhi

Phone: +91-11-2-6164175
Fax: +91-11-5-1659635

ITALY

Phone: +39-081-7892-111
Fax: +39-081-7892-208

JAPAN

Chiba
Phone: +81-43-297-9222
Fax: +81-43-299-1115

KOREA

Phone: +82-2-2274-0748
Fax: +82-2-2274-0794

MALAYSIA

Phone: +60-3-2161-0322
Fax: +60-3-2163-6312

MEXICO

Phone: +52-55-3640-5060

THE NETHERLANDS

Phone: +31-15-3808666
Fax: +31-18-1641438

RUSSIA

Veliky Novgorod
Phone: +7-8162-55-7898
Fax: +7-8162-55-7921

Moscow

Phone: +7 495-585-1276
Fax: +7 495-585-1279

SAUDI ARABIA

Phone: +966-3-341-0278
Fax: +966-3-341-7624

SINGAPORE

Phone: +65-6861-6100
Fax: +65-6861-7172

SOUTH AFRICA

Phone: +27-11-452-1550
Fax: +27-11-452-6542

SOUTH & CENTRAL

AMERICA AND THE CARIBBEAN
Phone: +55-12-2134-1201
Fax: +55-12-2134-1238

SPAIN

Phone: +34-93-652-6430
Fax: +34-93-652-6444

UNITED ARAB EMIRATES

Phone: +971-4-8991-777
Fax: +971-4-8991-778

UNITED KINGDOM

Bracknell
Phone: +44-1344-460-500
Fax: +44-1344-460-537

Skelmersdale

Phone: +44-1695-526-00
Fax: +44-1695-526-01

UNITED STATES

Massachusetts
Phone: +1-508-586-4600
Fax: +1-508-427-8971

Corpus Christi, Texas

Phone: +1-361-881-8182
Fax: +1-361-881-8246

Deer Park, Texas

Phone: +1-281-884-1000
Fax: +1-281-884-1010

Houston, Texas

Phone: +1-281-671-1640
Fax: +1-281-671-1735

* Denotes a trademark of General Electric Company.

Other company names and product names used in this document are the registered trademarks or trademarks of their respective owners.

© 2015 General Electric Company. All rights reserved.

